

MIXPAC™ F-System



2-COMPONENT INDUSTRY
SOLUTIONS

 medmix

INDUSTRY 

OVERVIEW

MIXPAC™ F-SYSTEM

200/400 ML INDUSTRIAL SET

ACCESSORIES



ACCESSORIES

	ID	Article
	103663	TA 10-ET
	103664	TC 10-ET
	101656 101657 116166 116165	BSD 10-25 BSD 10-40 BSD 13-50 BSD 08-50
	300326	BSDQ 08-38
	102357 102358	LA 06-08 LA 10-00

OUTLET TIP

-  Straight Tip (D)
-  Luer Slip Tip (L)
-  Stepped Tip (T)

MIXER

-  ○ MFH (Helix)
-  ● MFQ (Quadro™)

200 mL

CARTRIDGE

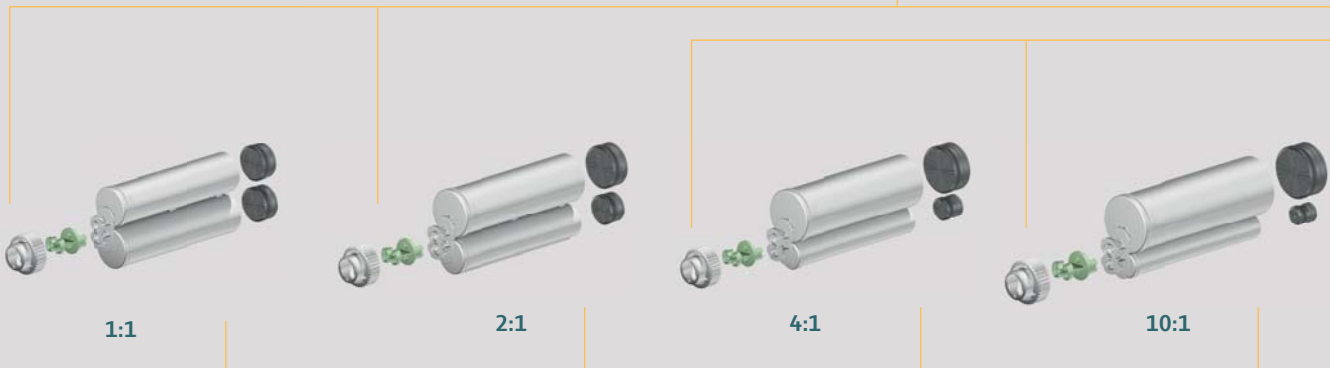

DISPENSER



INTERFACE CONVERTER

F-System => B-System



Ratio	ID	Article
1:1/2:1	128201	IBK 001-10
4:1/10:1	128202	IBKX 001-10

INTERFACE MIXER

B-System

Ratio	Article
1:1/2:1	MKH
4:1/10:1	MKHX

=> for further information see K-System



400 mL

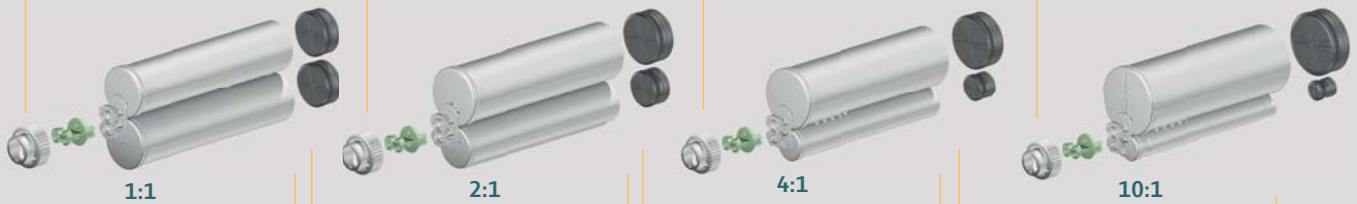

MIXPAC™ F-SYSTEM

CARTRIDGE SET

200 INDUSTRIAL SET





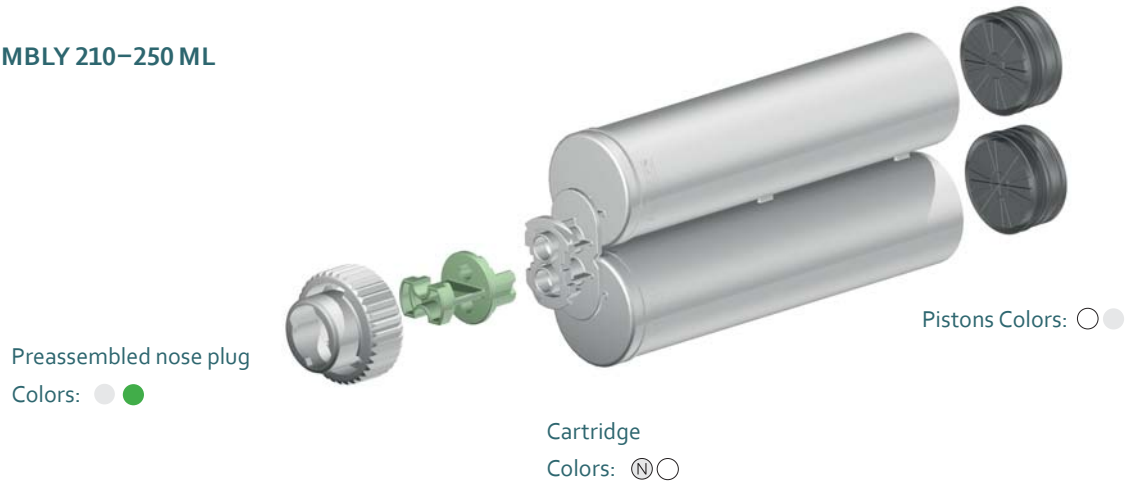

CARTRIDGE ASSEMBLY 210–250 ML





Ratio Set/ Volume	ID	Article	Cartridges Material/Color	Piston Material/Type	O-ring	Units/ Box	Mixer Technology	Matching Dispenser
1:1 200 mL	112390	AF 200-01-10-01	PP/Ⓝ	PP, self-venting	–	300	MFH ○ MFQ ●	DM ● DP ●
	128960	AF 200-01-10-05	PP/Ⓝ	PP, self-venting	–	300	MFH ○ MFQ ●	DM ● DP ●
	154401	AF 200-01-30-01	PA/Ⓝ	PA, self-venting	–	300	MFH ○ MFQ ●	DM ● DP ●
2:1 200 mL	112398	AF 200-02-10-01	PP/Ⓝ	PP, self-venting	–	280	MFH ○ MFQ ●	DM ● DP ●
	128607	AF 200-02-10-02	PP/Ⓝ	PP, self-venting	EPDM	280	MFH ○ MFQ ●	DM ● DP ●
	151831	AF 200-02-10-05	PP/Ⓝ	PP, self-venting	–	280	MFH ○ MFQ ●	DM ● DP ●
	159748	AF 200-02-30-05	PA/Ⓝ	PA, self-venting	–	280	MFH ○ MFQ ●	DM ● DP ●
4:1 200 mL	112393	AF 200-04-10-01	PP/Ⓝ	PP, self-venting	–	265	MFHX ● MFQX ●	DM ● DP ●
10:1 200 mL	112402	AF 200-10-10-01	PP/Ⓝ	PP, self-venting	–	250	MFHX ● MFQX ●	DM ● DP ●
	128961	AF 200-10-10-05	PP/Ⓝ	PP, self-venting	–	250	MFHX ● MFQX ●	DM ● DP ●
	167264	AF 200-10-20-01	PBT/Ⓝ	PA, self-venting	–	250	MFHX ● MFQX ●	DM ● DP ●
	167263	AF 200-10-20-05	PBT/Ⓝ	PA, self-venting	–	250	MFHX ● MFQX ●	DM ● DP ●

MATCHING MIXERS

	ID	Article	Number of Elements	Inner Diameter Ø mm/inch	Waste Volume (mL)	Units/Box	Outlet Tip			Accessories									
							Stepped Tip (T)	Straight Tip (D)	Luer Slip Tip (L)	TA10-ET	TC10-ET	LA06-08	LA10-00	BSD-08-50	BSD-10-25	BSD-10-40	BSD-13-50	BSDQ-08-38	
1:1/2:1 MFH 	102466	MFH 06-18T	18	6.0/0.236	4.36	1700	✓			✓									
	102467	MFH 06-24T	24	6.0/0.236	5.40	1400	✓			✓									
	116040	MFH 06-32T	32	6.0/0.236	6.65	1200	✓			✓									
	102468	MFH 08-18T	18	8.0/0.315	7.40	1400	✓			✓	✓								
	102469	MFH 08-24T	24	8.0/0.315	9.30	1200	✓			✓	✓								
	102470	MFH 08-32T	32	8.0/0.315	11.85	900	✓			✓	✓								
	102471	MFH 10-18T	18	10.0/0.394	13.09	1000	✓		✓	✓		✓		✓	✓				
	102472	MFH 10-24T	24	10.0/0.394	16.89	900	✓		✓	✓		✓		✓	✓				
	110583	MFH 10-32T	32	10.0/0.394	21.94	500	✓		✓	✓		✓		✓	✓				
	151603	MFH 13-18T	18	13.0/0.512	20.56	800	✓											✓	
	151604	MFH 13-24T	24	13.0/0.512	26.31	600	✓											✓	
	4:1/10:1 MFHX 	102473	MFHX 06-18T	18	6.0/0.236	4.16	1700	✓				✓							
		102474	MFHX 06-24T	24	6.0/0.236	5.20	1400	✓				✓							
113275		MFHX 06-32T	32	6.0/0.236	6.56	1200	✓				✓								
102475		MFHX 08-18T	18	8.0/0.315	7.28	1400	✓				✓	✓							
102476		MFHX 08-24T	24	8.0/0.315	9.14	1200	✓				✓	✓							
112720		MFHX 08-32T	32	8.0/0.315	11.55	900	✓				✓	✓							
102477		MFHX 10-18T	18	10.0/0.394	12.96	1000	✓		✓	✓		✓		✓	✓				
102478		MFHX 10-24T	24	10.0/0.394	16.70	900	✓		✓	✓		✓		✓	✓				
113250		MFHX 10-32T	32	10.0/0.394	21.22	500	✓		✓	✓		✓		✓	✓				
151605		MFHX 13-18T	18	13.0/0.512	20.73	800	✓											✓	
151606		MFHX 13-24T	24	13.0/0.512	26.48	600	✓											✓	
1:1/2:1 MFQ 	116032	MFQ 05-16L	16	5.3/0.209	2.90	2500		✓											
	116033	MFQ 05-24L	24	5.3/0.209	3.52	2000		✓											
	116034	MFQ 07-24T	24	7.5/0.295	6.11	1500	✓												
	115959	MFQ 08-24T	24	8.7/0.343	8.69	750	✓											✓	
	116734	MFQ 08-32D	32	8.7/0.343	11.10	800		✓											
	116035	MFQ 10-24T	24	10.7/0.421	14.75	600	✓												
4:1/10:1 MFQX 	116036	MFQX 05-16L	16	5.3/0.209	3.07	2500		✓											
	116037	MFQX 05-24L	24	5.3/0.209	3.69	2000		✓											
	116038	MFQX 07-24T	24	7.5/0.295	6.28	1500	✓												
	116039	MFQX 08-24T	24	8.7/0.343	8.86	750	✓											✓	
	116735	MFQX 08-32D	32	8.7/0.343	11.10	800		✓											
	116044	MFQX 10-24T	24	10.7/0.421	14.92	600	✓												

MATCHING DISPENSERS

	ID	Article	Ratio				Force (kN)
			1:1	2:1	4:1	10:1	
DM2X dispenser manual 	165803	DM2X 200-01-52	✓	✓			5.2
	165804	DM2X 200-04-52			✓		5.2
	165805	DM2X 200-10-52				✓	5.2
DP2X dispenser pneumatic 	165860	DP2X 200-01-25	✓	✓			2.5
	165861	DP2X 200-04-25			✓		2.5
	165862	DP2X 200-10-25				✓	2.5

CARTRIDGE SET

400 INDUSTRIAL SET





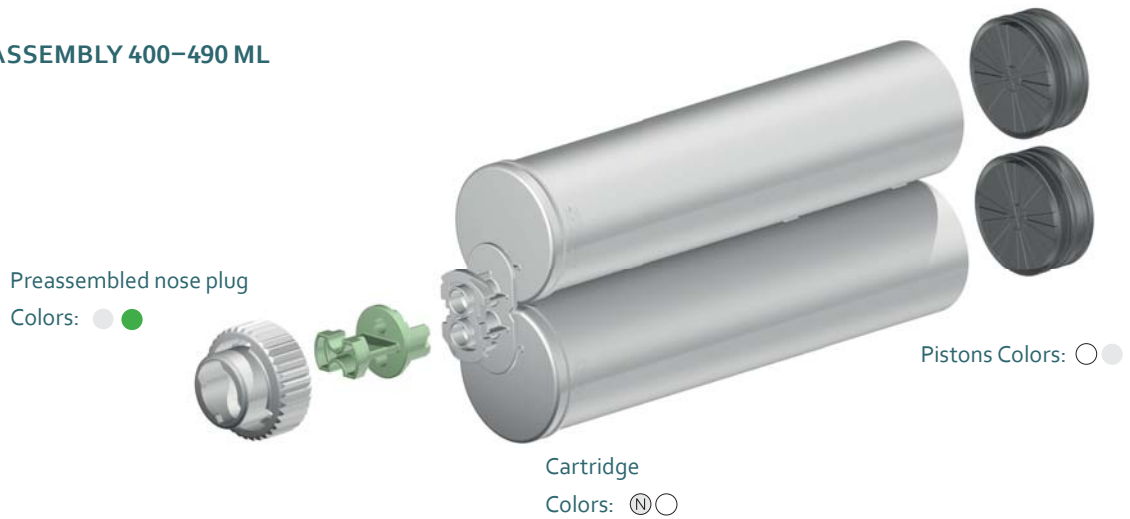

CARTRIDGE ASSEMBLY 400–490 ML





Ratio Set/ Volume	ID	Article	Cartridges Material/Color	Piston Material/Type	O-ring	Units/ Box	Mixer Technology	Matching Dispenser
1:1 400 mL	112410	AF 400-01-10-01	PP/(N)	PP, self-venting	–	180	MFH ○ MFQ ●	DM ● DP ● DB ●
	117111	AF 400-01-10-02	PP/(N)	PP, self-venting	EPDM	180	MFH ○ MFQ ●	DM ● DP ● DB ●
	128010	AF 400-01-10-05	PP/(N)	PP, self-venting	–	180	MFH ○ MFQ ●	DM ● DP ● DB ●
	167267	AF 400-01-20-04	PBT/(N)	PA, self-venting	–	180	MFH ○ MFQ ●	DM ● DP ● DB ●
	167266	AF 400-01-20-05	PBT/(N)	PA, self-venting	–	180	MFH ○ MFQ ●	DM ● DP ● DB ●
2:1 400 mL	112407	AF 400-02-10-01	PP/(N)	PP, self-venting	–	175	MFH ○ MFQ ●	DM ● DP ● DB ●
	113679	AF 400-02-10-02	PP/(N)	PP, self-venting	EPDM	175	MFH ○ MFQ ●	DM ● DP ● DB ●
	128959	AF 400-02-10-05	PP/(N)	PP, self-venting	–	175	MFH ○ MFQ ●	DM ● DP ● DB ●
	154807	AF 400-02-30-01	PA/(N)	PA, self-venting	EPDM	175	MFH ○ MFQ ●	DM ● DP ● DB ●
4:1 400 mL	112397	AF 400-04-10-01	PP/(N)	PP, self-venting	–	170	MFHX ● MFQX ●	DM ● DP ● DB ●
	167282	AF 400-04-20-01	PBT/(N)	PA, self-venting	–	170	MFHX ● MFQX ●	DM ● DP ● DB ●
10:1 400 mL	113745	AF 400-10-10-01	PP/(N)	PP, self-venting	–	165	MFHX ● MFQX ●	DM ● DP ● DB ●
	116612	AF 400-10-10-05	PP/(N)	PP, self-venting	–	165	MFHX ● MFQX ●	DM ● DP ● DB ●
	167187	AF 400-10-20-01	PBT/(N)	PA, self-venting	–	165	MFHX ● MFQX ●	DM ● DP ● DB ●
	167188	AF 400-10-20-03	PBT/(N)	PA, self-venting	–	165	MFHX ● MFQX ●	DM ● DP ● DB ●
	167186	AF 400-10-20-05	PBT/(N)	PA, self-venting	–	165	MFHX ● MFQX ●	DM ● DP ● DB ●

MATCHING MIXERS

	ID	Article	Number of Elements	Inner Diameter Ø mm/inch	Waste Volume (mL)	Units/Box	Outlet Tip			Accessories									
							Stepped Tip (T)	Straight Tip (D)	Luer Slip Tip (L)	TA10-ET	TC10-ET	LA06-08	LA10-00	BSD-08-50	BSD-10-25	BSD-10-40	BSD-13-50	BSDQ-08-38	
1:1/2:1 MFH 	102466	MFH 06-18T	18	6.0/0.236	4.36	1700	✓			✓									
	102467	MFH 06-24T	24	6.0/0.236	5.40	1400	✓			✓									
	116040	MFH 06-32T	32	6.0/0.236	6.65	1200	✓			✓									
	102468	MFH 08-18T	18	8.0/0.315	7.40	1400	✓				✓	✓							
	102469	MFH 08-24T	24	8.0/0.315	9.30	1200	✓				✓	✓							
	102470	MFH 08-32T	32	8.0/0.315	11.85	900	✓				✓	✓							
	102471	MFH 10-18T	18	10.0/0.394	13.09	1000	✓			✓	✓		✓	✓	✓				
	102472	MFH 10-24T	24	10.0/0.394	16.89	900	✓			✓	✓		✓	✓	✓				
	110583	MFH 10-32T	32	10.0/0.394	21.94	500	✓			✓	✓		✓	✓	✓				
	151603	MFH 13-18T	18	13.0/0.512	20.56	800	✓											✓	
	151604	MFH 13-24T	24	13.0/0.512	26.31	600	✓												✓
	4:1/10:1 MFHX 	102473	MFHX 06-18T	18	6.0/0.236	4.16	1700	✓				✓							
		102474	MFHX 06-24T	24	6.0/0.236	5.20	1400	✓				✓							
113275		MFHX 06-32T	32	6.0/0.236	6.56	1200	✓				✓								
102475		MFHX 08-18T	18	8.0/0.315	7.28	1400	✓					✓	✓						
102476		MFHX 08-24T	24	8.0/0.315	9.14	1200	✓					✓	✓						
112720		MFHX 08-32T	32	8.0/0.315	11.55	900	✓					✓	✓						
102477		MFHX 10-18T	18	10.0/0.394	12.96	1000	✓			✓	✓		✓	✓	✓				
102478		MFHX 10-24T	24	10.0/0.394	16.70	900	✓			✓	✓		✓	✓	✓				
113250		MFHX 10-32T	32	10.0/0.394	21.22	500	✓			✓	✓		✓	✓	✓				
151605		MFHX 13-18T	18	13.0/0.512	20.73	800	✓												✓
151606		MFHX 13-24T	24	13.0/0.512	26.48	600	✓												✓
1:1/2:1 MFQ 		116032	MFQ 05-16L	16	5.3/0.209	2.90	2500		✓										
	116033	MFQ 05-24L	24	5.3/0.209	3.52	2000		✓											
	116034	MFQ 07-24T	24	7.5/0.295	6.11	1500	✓												
	115959	MFQ 08-24T	24	8.7/0.343	8.69	750	✓												✓
	116734	MFQ 08-32D	32	8.7/0.343	11.10	800		✓											
	116035	MFQ 10-24T	24	10.7/0.421	14.75	600	✓												
	4:1/10:1 MFQX 	116036	MFQX 05-16L	16	5.3/0.209	3.07	2500		✓										
116037		MFQX 05-24L	24	5.3/0.209	3.69	2000		✓											
116038		MFQX 07-24T	24	7.5/0.295	6.28	1500	✓												
116039		MFQX 08-24T	24	8.7/0.343	8.86	750	✓												✓
116735		MFQX 08-32D	32	8.7/0.343	11.10	800		✓											
116044		MFQX 10-24T	24	10.7/0.421	14.92	600	✓												

MATCHING DISPENSERS

	ID	Article	Ratio				Force (kN)
			1:1	2:1	4:1	10:1	
DM2X dispenser manual 	165803	DM2X 200-01-52	✓	✓			5.2
	165804	DM2X 200-04-52			✓		5.2
	165805	DM2X 200-10-52				✓	5.2
DP2X dispenser pneumatic 	165860	DP2X 200-01-25	✓	✓			2.5
	165861	DP2X 200-04-25			✓		2.5
	165862	DP2X 200-10-25				✓	2.5
DB2K dispenser battery 	152603	DB2K 400-01-500	✓				5.0
	152605	DB2K 400-02-500		✓			5.0
	152607	DB2K 400-04-500			✓		5.0
	152609	DB2K 400-10-500				✓	5.0

DELIVERING INNOVATION. INSPIRING CONFIDENCE.

EUROPE

medmix Switzerland AG

Ruetistrasse 7

9469 Haag, Switzerland

Phone +41 81 414 70 00

sales.industry@medmix.com

www.medmix.swiss

USA, SOUTH AMERICA, CANADA AND MEXICO

medmix USA Inc.

8 Willow St.

Salem, NH 03079, USA

Phone +1 603 893 2727

sales.industry@medmix.com

www.medmix.swiss

UK AND IRELAND

medmix UK Ltd.

1 Tealgate, Charnham Park, Hungerford
Berkshire, RG17 0YT, United Kingdom

Phone: +44 (0)1488 647 800

sales.industry@medmix.com

www.coxdispensers.com

ASIA PACIFIC

medmix China Ltd.

68 Bei Dou Lu, Minhang Shanghai
200245, China

Phone: +86 21 6430 68 68

sales.industry@medmix.com

www.medmix.swiss



Legal Notice: This brochure is a general presentation. The information contained in this publication is believed to be accurate and reliable but is not to be construed as implying any warranty or guarantee of performance. We waive any liability and indemnity for effects resulting from its application. Please, contact us for a description of the warranties and guarantees offered with our products. Directions for use and safety will be given separately. All information herein is subject to change without notice.

© 2022 medmix Switzerland AG All rights reserved.

medmix is a trademark belonging to medmix AG, and MIXPAC is a trademark belonging to medmix Switzerland AG.